



FASTRAC | 8000 SERIES

Max power: 279hp (208kW) – 306hp (228kW) Lift capacity: 10 tonnes





**More power. More efficiency. More traction. More comfort.
And that means more profit.**

8000 SERIES FASTRAC



Today, smart business means focusing on keeping life-long machine costs down as the key to real profitability. No one knows this better than JCB, and our 8000 Series Fastracs achieve the perfect balance of high power, remarkable efficiency, ultimate versatility and legendary JCB quality. Together with industry-leading safety and comfort – investing in the operator to extend working potential – the 8280 and 8310 have the ability to achieve incredible levels of productivity and increase your profitability.

The JCB Fastrac is still the world's only full draft tractor with all-round suspension; and the world's only tractor that can legally travel on the road at speeds of up to 70kph. Add to this, outstanding levels of traction, the ability to handle the largest implements, a class-leading cab and a focus on developing efficient technologies to drive down machine fuel use and running costs. The result is a tractor that you can use all year round to get much more done, much more quickly for much, much less.

01 All-round suspension with integrated chassis

irons out bumps for a more productive ride, better power transmission to ground, no power hop

02 Sisu 8.4l 6-cylinder engine

offers more power and torque for supreme performance and low running costs

03 V-TRONIC transmission

fine-tunes engine to task for greater fuel economy

04 SCR (Selective Catalytic Reduction) technology

for a cleaner environment and the ultimate in tractor efficiency

05 Perfect weight distribution

better traction, better application of power, reduced tyre wear

06 Large external disc brakes with ABS

excellent cooling, fade-free braking and simple service access with safe, controlled, stopping on the road

07 Mechanical steering system with power assistance and GPS autosteer preparation

responsive, fail-safe steering on-road and with GPS in-field ensures every inch of soil is used

08 Category 2 electronic front linkage

precise fingertip control, external buttons make hitching up implements easier





09 The finest cab in the industry, bar none with full size passenger seat

spacious with lots of storage, for daylong, productive working

10 Headland Turn Assist

simple to set up, providing effortless control of tractor functions for greater output

11 Class-leading hydraulic flows

decrease cycle times and increase machine versatility

12 Ergonomic, intuitive control layout with full colour touch screen

easy to use no matter what the level of operator expertise and conveniently close to hand for quick, precise control

13 Mid-mounted cab away from rear wheels

avoids jolting the driver for enhanced performance, and gives better forward visibility

14 Nearly 6m² of glass with intelligent climate control and brighter road and field lighting packages

incredible visibility for safe working well into the night with the perfect temperature no matter how extreme the conditions

15 Activ Traction

minimises wheel slip to improve in-field performance

16 Dynamic axle mounting system

isolates implements from jolts, prolonging implement life and giving more productive performance

17 High capacity 10,000kg rear linkage and rear hitch camera

makes hitching even the largest implements and trailers effortless

Engine innovation

You told us you wanted more horsepower. The 8000 Series delivers, utilising a Sisu 8.4l 6-cylinder engine, offering more power and torque at low revs, combined with fuel efficiency, low noise levels and Tier 4 interim (Stage 3B) compliance.

The result is a machine that is kind to the environment and to your wallet, supplying exactly the right level of power, no more no less than you need, to keep running costs low for enhanced profitability. It also increases your output, with the ability to power even the largest implements and perform in the toughest conditions. Put simply, the 8000 Series enables you to do more for less.

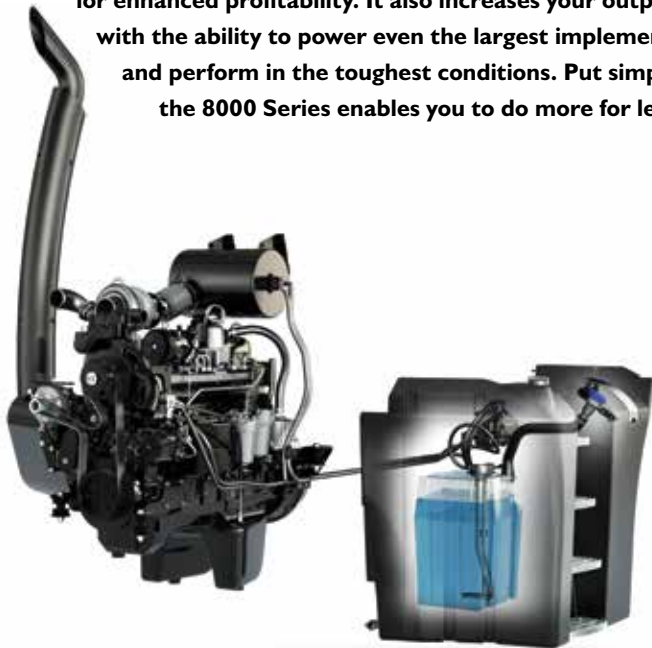

Efficient technology

The new 8000 Series uses SCR (Selective Catalytic Reduction) technology to achieve Tier 4 interim (Stage 3B) compliance

SCR uses AdBlue®, a urea-based solution. This is injected into the exhaust gas to drastically reduce NOx and particulates. This helps protect the environment, but also reduces your input costs, lowering fuel consumption. Given the arduous power and torque conditions our tractors experience, this makes SCR the ideal solution for the Fastrac

By separating engine timing and exhaust after-treatment, SCR also optimises combustion.

The new 8000 Series offers more power and more torque, with no increase in running costs

Matched driveline

The engine and transmission work seamlessly together to give you the perfect power and gear mix and ensuring no losses: every last ounce of available power is put to work for your business.

Consistently high quality

Wet cylinder sleeve design and advanced piston rings can reduce oil consumption by up to 30% and ensure uniform quality. Protecting your investment and maximising your revenue.

Cyclonic pre-cleaner

Uses centrifugal force to remove large dust particles before they enter the filter element, helping to reduce routine maintenance and improve efficiency even further.

Power-to-weight ratio

Maximised for improved performance in transport applications for great versatility.

Built to last

With some engines around the world still working, without any major overhaul and with in excess of 32,000 hours, you can be sure of the consistent performance and proven reliability these engines will deliver.

Do more for less

Power levels on the 8000 Series are high - 279hp on the 8280 and 306hp on the 8310. So whatever implement you need to use - you always have the ideal level of power for efficient, productive and versatile working. Add high torque rise levels - up to 38% - and you can overcome the most challenging conditions with no break in productivity.

8000 machines achieve all of this at reduced fuel levels for greater efficiency and therefore lower running costs and higher returns. The 8000 Series also operates at lower revs, reducing noise levels significantly; so much so, in fact, that these machines may not sound as powerful as they actually are. The result of this serene environment is that the operator may not want to leave!

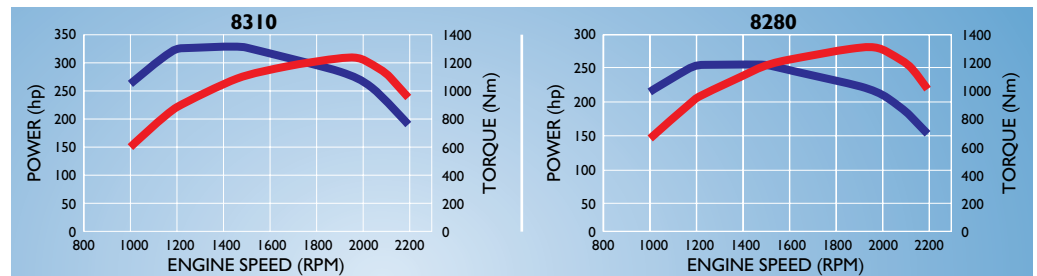



V-TRONIC transmission

The V-TRONIC is a continuously variable transmission that allows you to fine tune engine speed to get implements working at optimum performance levels. It means you can run engines at lower speeds for greater fuel economy and reduced running costs to keep you more profitable. And it gives the operator a more comfortable ride, for daylong productivity.



Effortless control, maximum economy

The V-TRONIC allows for effortless manual control using the armrest-mounted joystick. Alternatively, a suite of automatic cruise control features allow the operator to achieve maximum performance and economy for the machine, simplifying the task and allowing the operator to give it his full attention. Plus, by allowing the transmission electronics to communicate with the engine electronics, the tractor can control both automatically if required. This helps achieve maximum performance or economy automatically.

JCB front and rear axles

- Super-finished crown wheel and pinion increases efficiency and strength
- Integral cast design linkage gives immense strength: 10,000kg rear linkage can handle the largest of implements enhancing versatility and potential machine use throughout the year

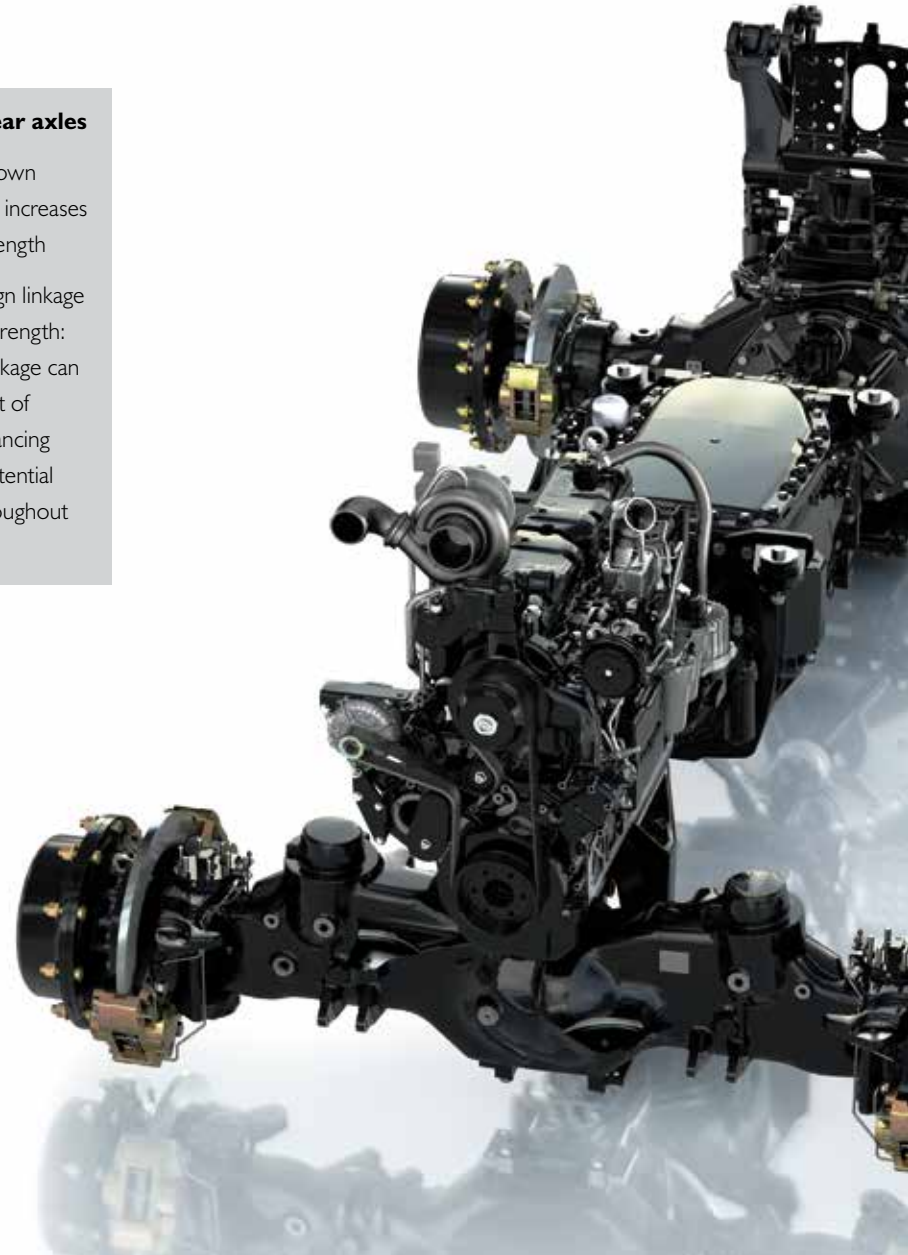

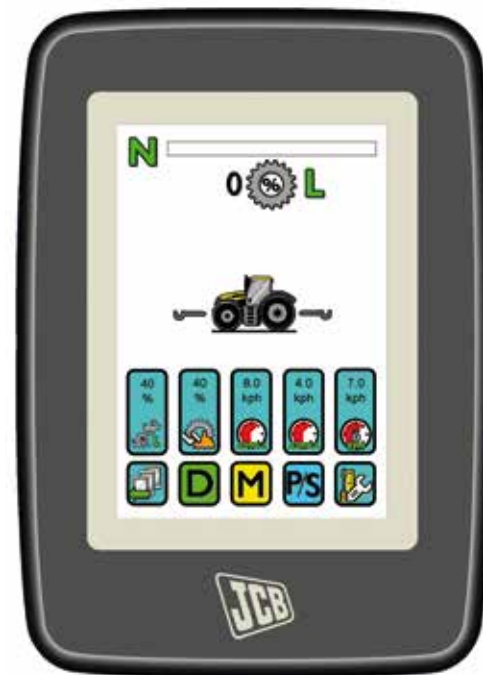

Efficient technology

NEW road and field controls ensure the 8000 Series operates at the engine speed setting for the task in hand, minimising fuel usage.

The V-TRONIC advantage

- Basic transmission operations are effortlessly controlled by the joystick
- Two transmission ranges tailor the machine to field operations and high-speed operations
- Touchscreen allows you to easily tune the transmission to the task
- Four transmission modes give you flexibility and efficiency for each application
- 2 additional load-sensing cruise control modes help to refine machine operation for further efficiency

User selectable transmission modes for optimum performance, versatility and efficiency

Simply use the full-colour, seat-mounted touchscreen to select between:

Drive – the transmission behaves like an automatic car, perfect for travelling between fields or for transport work; just hit the foot throttle and go. This includes an on-road cruise control for longer journeys.

Manual – using the joystick controller the operator has full, extremely precise control of the transmission for maximum adjustability.

Powershift – the transmission emulates a traditional powershift with 15 forward/12 reverse 'gears' in low range and 10 forward/7 reverse in high range. This is ideal for operators who are used to conventional powershift transmissions as they require very little training and can be more productive, more quickly.

Flexi – the operator sets the engine speed and maximum forward speed that can be achieved. The foot throttle is then used to vary forward speed between zero and the maximum forward speed setting. Ideal for harvesting operations.

Auto 1 and Auto 2 – automatically maintains a set speed for field applications, just press and hold the green button to save the working speed and the tractor takes care of the rest; automatically reducing engine rpm to the most efficient point to minimise input costs.

Rev hold mode – maintains revs and varies tractor speed up to the pre-defined limit to get maximum output of the machine.

This all means that the operator can concentrate on the task in hand, rather than on controlling the tractor, resulting in: better concentration, fewer mistakes, optimum tractor efficiency and improved productivity.

All-round suspension

When we launched the Fastrac in 1991, it was the only draft tractor with full front and rear suspension. It still is. And because no other tractor offers all-round suspension, no other tractor can enjoy the productivity and safety enhancing benefits of such a system. The Fastrac is truly unique.

The 8000 Series now also boasts improved front and rear suspension geometry for a more predictable and responsive machine at speed. The result is a serious performance advantage over the competition, both in the field and on the road.

Chassis design

The 8000 Series Fastracs feature a chassis designed for strength, stability and load carrying ability. The fully welded, Z-section design copes with stress without excessive increase in weight. This makes it better suited to carrying large implements with improved weight distribution than a more conventional, stressed heavy-casting design.

Chassis design ensures optimum visibility to the front of the machine and a stiffened front end improves handling on the road. This design allows you to see right down to the hook ends of the front linkage.



Faster to get to the job, faster to get the job done

The benefits of all-round, quad-link suspension with an integrated chassis are undeniable:

1. Increased speeds on highways with enhanced safety and control. 8000 Series machines are faster to get to the job, resulting in greater productivity.
2. Reduced compaction and increased traction, with no need to add dead weight. The wheels follow the contours of the ground, rather than bouncing over the ground and compacting the soil and reducing the soils' yield.
3. Full front and rear axle suspension rather than cab suspension means that the GPS receiver remains steady. This allows for greater accuracy when on the way-line, resulting in straighter, more accurate runs for lower input costs and less wastage.
4. Load-compensating, self-levelling rear suspension maintains constant ride for increased profitability.
5. Wheels follow ground contours and eliminate power hop, maintaining traction, increasing pulling power and ensuring all the engine power is transferred to the ground for more efficient working.
6. Greater operator comfort reduces fatigue levels and extends the working day: you get more done.

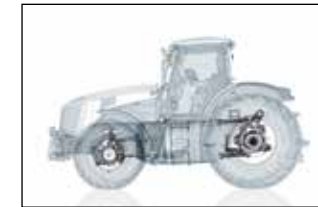

Fig. 1. No weight



Fig. 2. Weight added



Fig. 3. Weight adjusted level

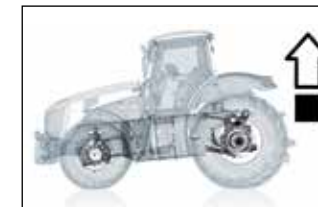

Fig. 4. Weight removed

Self-levelling rear suspension

The suspension automatically adjusts to the height of the implement, maintaining optimum ride height and giving better wheel compliance for maximum traction and minimum compaction:

As weight is applied:

- the chassis is lowered in relation to the rear axle (fig 2)
- the ride height corrector valves allow oil to flow in
- this pressurises the hydraulic cylinders which:
 - a) steadily restores original ride height (fig 3)
 - b) increases suspension stiffness to accommodate the extra weight

As weight is removed:

- sensors detect the change in height (fig 4)
- ride height corrector valves are displaced in the opposite direction
- this restores ride height to the pre-set level (fig 1)

Manoeuvrability and control

The 8000 Series Fastrac offers that rare combination of productive road and field performance: versatility that allows you to profit from every last drop of machine capability.

The 8000 Series Fastrac is the only heavy draft tractor legally allowed to travel at 70kph on the road, with responsive steering and safe stopping. This not only gets you to the next task more quickly, it also ensures increasingly important duty of care safety issues are fulfilled. At the same time, these incredible machines offer high-speed performance in the field, with effortless control at the headland, for reduced man hours and improved productivity.



On the road...

Power-assisted steering gives precise control from a light touch. The system is also designed for safety, with the back-up of a mechanical link steering system to maintain control and protect your investment and the operator in the event of engine failure.

Also with an eye on road safety – critical when you reach the high speeds of the 8000 Series – is the JCB controlled, fade-free braking system featuring ABS. This industry-leading braking system makes Fastrac the first ever tractor to be fitted with truck standard ABS brakes, a four-wheel, independent outboard system which can fully support these high speeds.



In the field...

The front suspension configuration and chassis are designed to allow the tightest possible steer angle, allowing you to whip the 8000 Fastrac around on the most confined headland for quicker cycle times and more productivity. For further simplicity, headland manoeuvres can be dealt with at the touch of one button (see pages 16/17 for more information).

The JCB braking system also gives additional in-field directional stability when working on grass or stubble, as well as loose surfaces like dirt and gravel.

Stay safe, controlled, stable and productive

- Large external disc brakes on each wheel offer excellent cooling and fade-free braking, make service and replacement incredibly easy and help to avoid contamination.
- Air-over hydraulic systems are split between front and rear axles for added safety
- Greater braking power on the front axle (like on a car) gives full control even in an emergency
- Twin calliper system provides phenomenal stopping power
- Independent parking brake and full trailer braking equipment as standard
- System meets EU truck standards

Focus on innovation

Anti-lock braking system (ABS)

Proven truck technology adapted for tractors:

- **Slower reacting,** compensates for large diameter wheels.
- **4-Sensor, 3-modulator system** provides constant monitoring of all wheels and independent control of rear wheels. A high level of control is paramount as directional stability is at its greatest on the rear wheels, but independent modulation gives confidence and control during braking.
- **12-Volt trailer abs supply socket** provides a power supply to a trailer ABS system that works independently of the tractor's system.

Please note: without a dedicated supply some agricultural trailers takes the ABS power supply direct from the standard 7-pin trailer lighting socket. Very often this can overload the wiring system.





GPS autosteer

Increased efficiency and productivity

Greater area coverage – achieved through consistent use of the full working width of machine and implement

More efficient working pattern – ensuring you get the maximum productivity from every square inch of land

True precision – with no overlaps and no misses

Total accuracy – even in poor visibility and, thanks to the full suspension system reducing GPS receiver movement, on bumpy ground

Fast, accurate lock-on to way lines – thanks to the rear GPS receiver mounting position

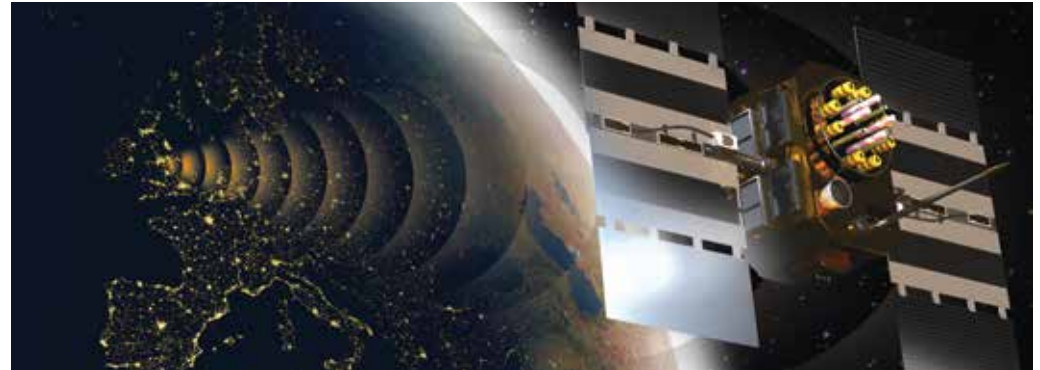

Efficient technology

NEW GPS 'ready' system can reduce inputs and increase efficiency by up to 10%.

For machine safety, when GPS is not required - ie, on the road - patented JCB technology allows the tractor to revert to mechanical link steering which allows safe control at high speed.

Reduced operating costs

Less wastage – thanks to greater accuracy and precision means lower costs for seed, fertiliser, pesticide, fuel and man hours

Reduced working width and overlaps – research proves these to be bigger without GPS resulting in increased diesel, machine, fertiliser and protection product costs

More operator productivity – thanks to a system that requires less concentration, reducing fatigue and extending the working day

Simple, precise control

Integrated system – is easy to activate leaving the operator free to concentrate on the implements and the task in hand, rather than on driving in a straight line and minimising overlap

Fast, precise, sensitive steering corrections – via the patented proportional steering valve with feedback to the driver as the steering wheel turns

Easy to use – allowing even novice operators to achieve high productivity levels

Easily overridden – when necessary by moving the steering wheel to regain manual control

The 8000 Series GPS 'ready' system has the ability to reduce inputs and increase efficiency by as much as 10%. Every inch of the field is used, reducing waste and ensuring you get more out of the land; operating costs are lowered with less seed, fertiliser, pesticide and fuel used per task; and operation is easier, requiring less concentration for reduced fatigue and man hours.

The combined result is an already productive machine made even more productive than you ever thought possible.





Headland turn assist

True 'one touch' headland management with up to 15 pre-set functions, including the incorporation of speed control, throttle and GPS activation. This system saves valuable time by efficiently handling tractor and implement manoeuvres at the headland, leaving the driver free to focus on the in-field task.

The result? Increased concentration, fewer mistakes, faster working and huge productivity.

Even the most complicated operations, made simple

The Headland Turn Assist (HTA) function is accessible via the touchscreen and is easily programmable while stationary or on the move, so even less-skilled operators can use it. The system offers the following:

- Ability to program a sequence of up to 15 tractor operations to perform at the touch of a single button
- Ability to store up to 5 of the above sequences for different operations
- Single-button activation with a button on the joystick within easy reach
- Simple selection of functions: just press the function required on the touchscreen menu; no confusion with trying to record a number of tasks
- Ability to insert, modify or delete functions, even during operation, for maximum flexibility
- Ability to link functions together with a timing or distance delay feature or to step through the process with a single button press
- Option to pause, restart and skip through sequence to cope with obstacles
- Available with the field performance package – to utilise the radar for precise distance delay measurements





Balance, stability and traction

The 8000 Series achieves perfect weight distribution, spreading the load to apply the engine power to the ground through increased traction, reduced tyre wear, and improved efficiency and implement handling. A balanced machine also results in better weight transfer with mounted implements for excellent stability and control.

Add the new Activ Traction feature and you have a tractor designed to take performance levels to new heights, no matter what the ground conditions.

Innovation in action

▶ Activ Traction

A brand new feature for the 8000 Series is Activ Traction: designed to minimise wheel slip, automatically slowing the machine down to regain grip and then speeding up again, to improve in-field traction.

Activ Traction is included as part of the radar in the field performance package.

Improved traction

- Optimum weight distribution ensures maximum traction to make the best use of the available power
- All of the machine weight is integral to the machine so there is no need for ballasting which can change machine characteristics and make achieving optimum balance difficult and causing unnecessary compaction for increased yields
- More power means even the largest implements can be handled with no need to add extra ballast and all that power is efficiently applied to the ground



Improved implement handling

- Perfect weight distribution results in a smoother action for improved implement handling
- Full Fastrac suspension features rubber bushes within the suspension links, allowing the rear axle to rotate forwards and backwards to cushion the implement
- Cushioning minimises jolts, prolongs implement life, gives greater stability when travelling at speed and results in better wheel compliance for the front axle, for more stability and control
- As the rear trailer hitch is fitted to the rear axle (we have added a rear hitch camera option to make this easier), it provides hitch damping in a similar way
- The rear 3-point hitch also features hitch dampening, working in harmony with the suspension system and further cushioning the ride for the implement





Versatility

The 8000 Series Fastrac is designed to help you achieve maximum productivity and efficiency in a variety of in-field tasks. So class-leading hydraulic flows improve cycle times and flexibility, while implement connection is quick and easy thanks to fender-mounted buttons and a rear hitch camera.

But this is also a machine that you can use out of season, in poor winter ground conditions and for day-to-day tasks. Consummate versatility gives you more for your investment and even greater profitability for your business.

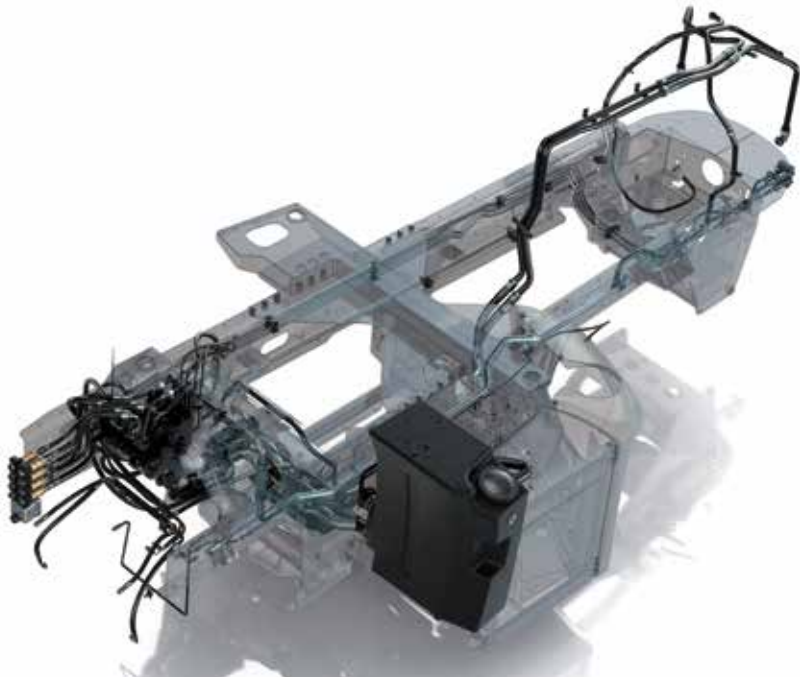

Perfect hydraulic flow

Power and precise control when you need them, via the easy-to-use touchscreen. 8000 Series Fastrac hydraulics ensure you always have the right option to hand, whatever the implements:

- Load-sensing variable displacement auxiliary hydraulic pump as standard, with class-leading optional maximum flow of 210 litres/min

- Big capacity, flow-on-demand hydraulics with 100-litre/min (or optional industry-leading 140-litre/min) maximum outputs per valve and are extremely responsive
- Priority flow option diverts flow to the green spool rather than linkage for flow-hungry hydraulic implements, such as hydraulic motors
- Optional load-sensing power beyond connection saves fuel and wear, and prevents excessive heat generation in the hydraulic system
- Electronically controlled spool valves let you adjust time and flow in both directions for automatic control of implements
- Segregated system avoids contamination from the driveline while auxiliary hydraulic oil is filtered in and out of the tank, keeping the system clean and preventing damage

Rear linkage

Operating implements is extremely accurate thanks to:

- Proven Bosch Hitchtronic system which helps maintain precise control of implement height, depth, lowering speed and general response
- Wheel slip control available with the optional field performance package to help achieve maximum progress in tough conditions
- High lift capacity (10,000kg)
- Optional automatic stabilisers which allow increased linkage movement
- Dynamic axle mounting system which ensures implements are isolated from jolts than can limit effectiveness
- Rear hitch camera which makes attaching implements quicker and easier

Optional front linkage

- 3,500kg chassis-mounted, category 2, electronic front linkage
- Gives both single and double actuation at the flick of a switch, as well as height, depth and rate of drop controls





Space and visibility



The largest cab on the market, bar none. The airy, spacious interior with exceptional legroom and storage space puts the operator at ease and encourages day-long, fatigue-free productivity. And take a look at the wide, panoramic view. With a 4-post design (instead of 6-post) eliminating side pillars and nearly 6m² of glass, visibility is unsurpassed.

Visibility is further enhanced by: a repositioned exhaust stack alongside the right-hand cab pillar; full-length doors and windows, contributing to a clear all-round view of implements, terrain and potential obstructions; optional heated front and rear windscreens; and, thanks to a bigger alternator, brighter road and field lighting packages which ensure a near-daylight operating environment.

Comfort, safety, control

The 8000 Series leads the industry when it comes to in-cab comfort and driver safety – no competitor comes close. Total comfort lowers fatigue levels, raises concentration and extends the working day; total safety protects you, your people and your business. These machines are designed to ensure your operator achieves optimum performance day in day out, earning more for your business.

And once the operator is in the most comfortable and productive position possible, our next step is to give novice and experienced operators alike the ability to get every last inch of performance potential out of these incredible machines, with ergonomic easy-to-use controls.

Ultimate comfort

As well as being the largest, most spacious cab on the market with incredible all-round visibility, the 8000 Series cab offers significant advantages:

Low noise – In-cab noise levels are extremely low for a more peaceful and less tiring working environment.

Access – Single, large forward-opening door and wide steps give easy access for enhanced safety. Door helps prevent dust getting into the cab again improving the environment to keep the operator productive.



Heating and cooling – *Solar glass treatment, high-output air conditioning and a high-performance heater matrix maximise comfort even in the most extreme climates, reducing stress and fatigue. Winter pack option and full climate control ensure windows are cleared instantly for minimum waiting; you can get on with the job more quickly.

**market dependent*

Seating – The air suspension seat is incredibly comfortable, while the full-size passenger seat (unique to JCB) ensures colleague comfort for productive partnership working.



Mirrors – Right-hand electric mirror as standard with additional options including twin electric mirrors, twin electric heated mirrors (as part of the winter pack) and an interior mirror, enhance visibility to protect the machine and colleagues.

Audio – 4-speaker system with an optional auxiliary audio input.

Consummate safety

We care about the safety of your operators just as much as you do. When working in hazardous environments it pays to minimise the risks. 8000 Series Fastracs are the safest of their kind on the market, thanks to:

- An industry-leading ABS braking system which ensures safe stopping even when travelling at 70kph
- Direct-link steering, anti-roll bars, outboard brakes and self levelling for safety no matter what the load
- New front fender design which reduces road spray for better visibility
- New 200 amp alternator and brighter road and field packages to ensure a near daylight environment

Innovation in action

The ultimate smooth ride

Full suspension

The only draft tractor with front and rear suspension:

- Provides ultimate operator comfort, reducing fatigue and improving concentration for greater output
- Irons out bumps and jolts in the field to keep implements working effectively, and again for improved operator productivity
- Enhances control and comfort, ensuring that your operators and the public are safe both in field and on the road



Revolutionary cab positioning

Mid mounting the cab gives a smoother ride when compared to cabs positioned over rear wheels which are susceptible to jolting, reducing stress on the operator for enhanced performance.

In addition:

- Load-compensating, hydro-pneumatic, self-levelling rear suspension maintains constant ride height for smooth performance
- Quad-link suspension ensures unrivalled driver comfort and load levelling



In total charge of machine and environment

The 8000 Series Fastrac cab design helps to reduce the mental and physical stress that can sap operator productivity. So the ergonomic layout minimises repetitive and tiring twisting and stretching. Controls are easy-to-use and intuitive featuring a number of automated key operations, such as forward speed and headland turns, that leave the operator free to concentrate on the job in hand.

The full-colour touchscreen features a simple, extremely easy to use layout, putting you in complete control of transmission modes (see pages 8/9) and, at the touch of a button, Headland Turn Assist (see pages 16/17), for maximum efficiency.



Touchscreen machine setup control includes:

- PTO cut outs front/rear
- Difflock cut-outs
- Display setup
- Area cut-outs
- Programmable joystick buttons setup
- Spool valve time and flow setup
- Headland Turn Assist set up menu
- Worklight setup menu
- Service access



Touchscreen machine status control includes:

- PTOs when running and PTO RPM
- PTO gear selected
- Active spool valves
- Headland Turn Assist sequence and next function to be activated
- Difflocks and 4WD (flashes is inactive)
- Linkage control and draft control movement
- Selected direction

Quality and reliability

The 8000 Series builds on a history of reliability and build quality since 1991, during which time Fastracs have proven themselves in some of the world's most extreme climates and conditions. Over the last two decades we have invested in continual research and development to ensure our machines keep getting better and better.

The 8280 (which replaces the successful 8250) and the 8310 represent a step forward in Fastrac quality and reliability, for a solution you can trust 100%.



Original prototype 1991



185 Fastrac – 1994



3155/3185 Fastrac – 1998



3190/3220 – 2002

A history of quality and innovation

- 1991 – Production of 100 Series Fastracs begins
- 1995 – Production of smaller 50kph 1100 Series Fastracs begins
- 1996 – Quadtronic 4WS introduced
- 1998 – Fastrac 2000/3000 Series replaces 1100/100
- 2000 – Smoothshift oil-immersed wet clutch introduced
- 2001 – ABS braking available on all ranges
- 2005 – Fastrac 8250 launched with 8.3-litre Cummins engine and V-TRONIC transmission
- 2006 – Fastrac 3200 and 3230 launched with 6.7-litre Cummins engine
- 2007 – Fastrac 2155 and 2170 launched
- 2008 – Fastrac 7000 Series launched, redefining one of the world's outstanding high-performance tractors
- 2010 – Fastrac 3000 Series Xtra launched, incorporating the P-TRONIC transmission
- 2011 – New Fastrac 8280 and 8310 launched

Quality control and reliability

- Thorough checks, conducted throughout the entire build process, ensure quality every step of the way
- Dynamometer testing of every machine verifies engine performance
- Gruelling hot test analysis checks the whole vehicle including engine, transmission, hydraulics and brakes
- Intensive PDI process ensures an impeccable quality control
- Electrophoretic painting (EPD) of key components guarantees improved paint adhesion, ensuring durability and maximum protection of residual value
- Electro-plated cooling pack components minimises corrosion
- Full chassis construction means that, unlike conventional tractors, the engine and transmission are not stressed, load-bearing components
- Heavy-duty front suspension is extremely robust



Cost of ownership

Keeping lifetime machine costs down is key to long-term profitability. 8000 Series Fastracs combine high productivity and versatility with low running costs, minimum downtime and maximised residuals. These are machines that represent a smart investment for your business, giving you efficient service season after season.



High productivity and lower running costs

- Powerful engines with high levels of torque and excellent efficiencies reduce running costs with no compromise on productivity
- GPS autosteer reduces inputs and increases efficiency by as much as 10%, ensuring every inch of the field is used for reduced seed, fertiliser, pesticide and fuel costs
- Consummate versatility gives you greater value for money - very few high horsepower tractors can genuinely be used all year round
- The unique Fastrac full suspension system reduces in-field compaction for lower crop establishment costs and greater crop productivity

Minimised downtime and quick, efficient servicing

- A proven history of build quality and reliability (see pages 26/27)
- New panniers on both sides of the machine ensure all daily checks are now at ground level for easy access, and kept free of dirt and debris
- New cooling pack and on-board compressor make regular cleaning simple and straightforward, for efficient machine running at all times
- New machine design improves sealing around the bonnet to minimise dust and debris entering the engine bay
- Improved positioning of filters and oil drains speeds up access and servicing
- Separate hydraulic system for auxiliary eliminates the risk of oil contamination
- Donaldson Powercore system uses centrifugal force to remove large dust particles before they enter the filter element, reducing routine maintenance
- Electronic Management System continuously monitors engine performance to increase service life
- After 100 and 500-hour service, engine oil and filters are renewed every 1000 hours, while top-end engine maintenance is only required every 5,000 hours
- Outboard disc brakes are easier to service
- Daily service requirements are all quickly and easily accessible
- JCB's industry leading customer support keeps you up and running



Agricultural heritage

From our first agricultural tipping trailer to a global brand

JCB is no run-of-the-mill company. From the dreams of one man, Joseph Cyril Bamford, and our beginnings in agricultural machinery, we have grown into a major world brand. Since 1945, the same attention to detail, passion for progress and intrepid family spirit has taken us from strength to strength.



JCB operates across all six continents, manufacturing at 17 factories in the UK, Brazil, Germany, China, North America and India. We have over 1,500 dealerships and depots selling and supporting our products in excess of 150 countries, we boast some of the finest engineering facilities in the world.

We're also renowned for producing some of the most innovative and popular farm machinery in the world, which includes the Fastrac and the world-beating Loadall, along with wheeled loading shovels that are designed specifically for farming, not adapted from construction.

Our dedication to innovation in agriculture is unceasing; we will never forget our roots.





JCB expertise

The best back-up in the business

JCB is renowned for providing legendary customer support. Our dealers are all specialists in agriculture so they know exactly what they're talking about. And of course, they're committed to ensuring that your 8000 Series completely fulfils its potential, ensuring you maximum uptime for optimum productivity.

At the heart of our support network is the JCB World Parts Centre, a state-of-the-art facility operating 24/7 to dispatch more than a million genuine parts and attachments every week to our dealers and distribution centres: we are there when you need us.

Just as important as genuine JCB parts are the people who fit and maintain them. Our JCB-trained technicians in all of our dealerships provide excellent, expert customer care, whether it's routine servicing or something more urgent.

It's all part of our commitment to putting the customer at the heart of our business.

**ABS
BRAKING**

FULLY SUSPENDED WITH 4 WHEEL ABS DISC BRAKING. JCB V-TRONIC TRANSMISSION.

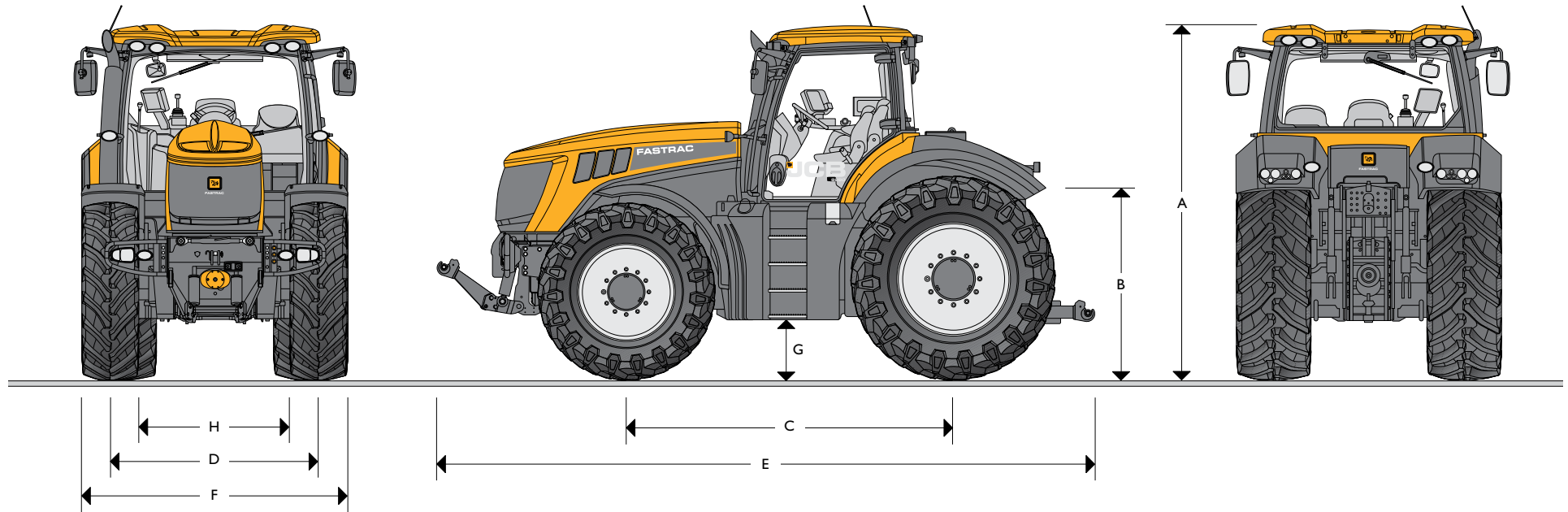

STATIC DIMENSIONS

Tyres	540/65 R38 Front and 710/70 R38 Rear	Tyres	540/65 R38 Front and 710/70 R38 Rear
m (ft-in)		m (ft-in)	
A	Height to exhaust	E	Overall length
B	Height to deck	F	Overall width
C	Wheelbase	G	Ground clearance
D	Track width (front/rear)	H	Width between tyres
	2.03 (6-8) / 1.84 (6-0)		1.10 (3-7)
	3.38 (11-1)		5.65 (18-6)
	1.51 (4-11)		2.55 (8-4)
	3.12 (10-3)		0.47 (1-6)



ENGINE

8280

8310

Gross hp at rated speed		256	280
Gross kW at rated speed		191	209
Max Power	hp	279	306
Max Power	kW	208	228
Max torque @ 1400 rpm	Nm	1195	1310
Rated engine speed	rpm	2100	
Max torque engine speed		1500	
Make		Sisu Power	
Model		AWI-IV-3B	
Injection		Bosch CP4 Common Rail	
No of cylinders		6	
Capacity	cc	8419	
Bore	mm	111	
Stroke	mm	145	
Cooling		Water	
Air cleaner		Powercore dry element	
Aspiration		Turbocharged and intercooled	

SUSPENSION

Front: Coil spring and damper, microcellular secondary spring.

Rear: Hydro-pneumatic self levelling.

ELECTRICAL SYSTEM

System voltage	Volt	12
Alternator output	Amp	200
Battery capacity	Amp hour	2 x 110 (950 cold cranking amps)

Electrical wiring – to IP67 standard.

CAPACITIES

	litres (UK gal)
Fuel tank	550 (121)
Hydraulic tank	180 (40)
Urea tank	70 (15)

HYDRAULICS

3 point linkage: Electronic draft/position intermix, rate of drop, adjustable lift height plus external lift and lower.

Rear hitch: 10,000kg (22,045lb) Category III; Quick attach hook ends, eye end top link.

Front hitch (optional): Lift capacity at link ends – 3500kgs, Category II; Quick attach hook ends, folding arms.

AUXILIARY HYDRAULICS

		Standard	Optional
Max oil flow	l/min	138	195
Flow at rated engine speed	l/min	126	178
Flow per slice	l/min	100	140

Operating pressure: 210 bar

Spool valves: Electronic 7 position double acting with flow and time control, float position and zero leak.

Standard: 3 spool valves to the rear

Optional: 4 spool valves to the rear.
Load sensing hydraulic connection.
1 or 2 front supplies.
Front free flow return.

Couplers: Deluxe Quick release/spill-off piped to reservoir (front and rear).

Pipework/hose: BSP standard.

**POWER TAKE OFF**

Type:	Fully independent to front and rear (front optional).
Actuation:	Electro-hydraulic.
Rear PTO speeds:	540 rpm @ 1570 engine rpm 1000 rpm @ 1930 engine rpm
Rear PTO output spline:	6 or 21 spline 1 $\frac{3}{8}$ " diameter 6 or 20 spline 1 $\frac{3}{4}$ " diameter (options)
Front PTO speed:	1000 rpm @ 2030 engine rpm
Front PTO output spline:	21 1 $\frac{3}{8}$ " diameter or 20 1 $\frac{3}{4}$ " diameter
PTO power:	8280: 245hp (183kW) 8310: 272hp (203kW)
Speed change:	Electro-hydraulic in cab switch. Front PTO only available at 1000 rpm.

AXLES

Type:	Beam with outboard epicyclic reduction hubs.
Wheel mountings:	10 stud front axle 16 stud rear axle
Four wheel drive selection:	On the move engage/disengage using rocker switch.
Differentials:	Front and rear locking with electro-hydraulic soft engagement.

STEERING

Type:	Re-circulating ball with power assistance and assistor ram.
Column:	Tilt and telescope adjustable.
Turning circle:	Kerb to kerb 14.8m

BRAKES

Type:	Outboard discs with twin callipers and ABS on all four wheels.
Operation:	Air over hydraulic to EEC truck specification.
Park brake:	Independent disc on transmission output.
Actuation:	Sprung on, air pressure off.
Trailer brakes:	Twin line air brakes. Single line hydraulic brakes for speeds up to 20mph. Air trailer brake automatically applied by tractor park brake. ABS 12v trailer supply socket as standard.

TRANSMISSION

Type:	2 range continuously variable transmission with 6 modes of operation
Speeds:	Low Range 0 – 45kph High Range 0 – 65kph

Powershift mode Gear	Forwards (kph)		Reverse (kph)	
	High	Low	High	Low
1	7.4	0.4	7.1	0.4
2	11.1	2.3	10.7	2.1
3	15.7	3.0	15.1	2.8
4	20.6	3.8	19.8	3.4
5	26.4	4.7	20.0	4.3
6	33.4	5.8	20.0	5.3
7	42.1	7.3	20.0	6.7
8	52.8	9.2	20.0	8.4
9	66.1	11.5	-	10.5
10	70*	14.2	-	13.0
11	-	17.5	-	16.0
12	-	21.7	-	19.8
13	-	26.9	-	-
14	-	33.4	-	-
15	-	41.7	-	-

540/65 R38 and 710/70 R38 tyres at rated engine speed (2100 rpm)

All other modes utilise stepless ratios.

* At 1780 rpm

**VEHICLE WEIGHTS**

Based on a 8280 shipping weight with no fuel on 540/65 R34 front and 650/65 R38 rear tyres with no driver and no ballast.

	Front axle	Rear axle	Total
	kg	kg	kg
Machine with front weight tray	5288	5143	10,431

WHEELS AND TYRES

4 welded wheels. Front directional and rear fixed and enclosed fenders. Fixed cab mounted fenders.
All tyres are speed rated for 65kph

Factory fit	Front tyres	Track width mm (in)	Rear tyres	Track width mm (in)
Trelleborg*	540/65 R34	1990 (78)	650/65 R38	1900 (75)
Trelleborg	540/65 R38	1990 (78)	710/70 R38	1834 (72)
Trelleborg	540/65 R38	1990 (78)	650/75 R38	1834 (72)

Vehicle width is retained within 2550mm. *Not available on 8310

CAB

High specification, single door, full width, low noise.

Standard equipment includes:

Fully automatic climate control.
Air suspension seat with armrest mounted transmission and auxiliary controls.
Colour touch screen display, providing transmission information and setup capability.
Electronic spool valves.
Full dust filtration.
Tinted glass.
Front and rear wash wipe.
Electrically adjustable right hand rear view mirror.
Full road lighting equipment.
Auxiliary electrical and speed sensor sockets.
Full size passenger seat.
Lap belt for driver and passenger.
Side console illumination.
Slimline blue backlit dashboard.
Storage compartment.
Radio preparation with single DIN slot and four speakers.
Sun blind.
Cable access through rear window.
Rear fender mounted raise/lower and PTO cut out switches.
8 front and 6 rear worklights.
Headland management system.

OPTIONAL EQUIPMENT

Front linkage (Category II) with electronic control and external raise/lower.
Front 1000 rpm PTO with 21 spline or 20 spline output shaft.
Four electronic spool valves.
Hi-flow hydraulics.
Load sensing hydraulic connection.
Front weight.
Rear deck weight.
1 or 2 front hydraulic services.
Front free flow return.
20 spline 1³/₄" PTO shaft.
6 spline 1³/₄" PTO shaft.
Radar and performance monitor.
Deluxe heated driver's seat.
Heated front and rear screens with heated and electric mirrors.
Left hand electrically adjustable mirror.
Xenon worklight package (2 front, 2 rear Xenon with 6 front, 4 rear standard).
Auxiliary audio input.
Deluxe double DIN radio preparation.
Interior rear view mirror.
Rear deck mounted toolbox.
Automatic rear linkage stabilisers.
Knuckle end top link.
GPS autosteer preparation
Rear hitch camera



ONE COMPANY, OVER 300 MACHINES.

Your nearest JCB dealer

Fastrac 8000 Series

Max power: 279hp (208kW) – 306hp (228kW) Lift capacity: 10 tonnes

JCB Agriculture, Rocester, Staffordshire, United Kingdom ST14 5JP.

Tel: +44 (0)1889 590312 Email: salesinfo@jcb.com

Download the very latest information on this product range at: www.jcb.com

©2014 JCB Sales. All rights reserved. No part of this publication may be reproduced, stored in a retrieval system, or transmitted in any form or by any other means, electronic, mechanical, photocopying or otherwise, without prior permission from JCB Sales. All references in this publication to operating weights, sizes, capacities and other performance measurements are provided for guidance only and may vary dependant upon the exact specification of machine. They should not therefore be relied upon in relation to suitability for a particular application. Guidance and advice should always be sought from your JCB Dealer. JCB reserves the right to change specifications without notice. Illustrations and specifications shown may include optional equipment and accessories. The JCB logo is a registered trademark of J C Bamford Excavators Ltd.

